

Features

- With overflow
- For use in overflow applications

Material

- Solid-brass construction for durability and reliability
- KOHLER finishes resist corrosion and tarnishing



Codes/Standards











ASME A112.18.2/CSA B125.2

KOHLER® One-Year Limited Warranty

See website for detailed warranty information.

Available Colors/Finishes

Color tiles intended for reference only.

Color	Code	Description
	CP	Polished Chrome
	SN	Vibrant™ Polished Nickel
	AF	Vibrant™ French Gold
	PB	Vibrant™ Polished Brass
	BN	Vibrant™ Brushed Nickel
	VS	Vibrant™ Stainless
	BV	Vibrant™ Brushed Bronze
	2BZ	Oil-Rubbed Bronze
	BL	Matte Black
	2MB	Vibrant™ Brushed Moderne Brass
	TT	Vibrant™ Titanium

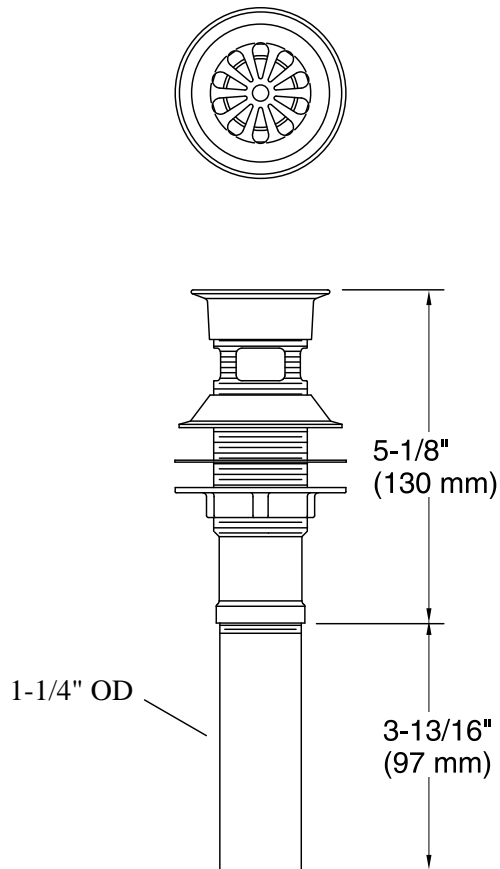

Technical Information

All product dimensions are nominal.

Notes

Install this product according to the installation guide.